

ecostrad

INSTRUCTION MANUAL

Ecostrad iQ Plus Electric Panel Heater



PLEASE READ AND SAVE THESE INSTRUCTIONS



**UK
CA**

Symbols



Warning

This symbol indicates a hazard with an average risk level which, if not avoided, could result in serious injury or death.



Warning of electrical voltage

This symbol indicates danger to the life and health of persons due to electrical voltage.



Do not cover

This symbol located on the device indicates that it is prohibited to place objects (such as towels, clothes etc.) above or directly in front of the device. To avoid overheating and fire hazards, the device must not be covered.



Hot surface

This symbol located on the device indicates that its surfaces are hot during and immediately after operation. Hot surfaces should not be touched: danger of burns.



Do not spray

This symbol located on the device indicates that it is prohibited to spray the device.



Observe instructions in manual

This symbol located on the device indicates that instructions in the operating manual must be observed when installing and using the device.

Contents

1	About the Manual	4
2	Warnings & Precautions	4
3	Technical Information	7
4	Installation	7
4-1	Fixings	7
4-2	Wall mounting instructions	8
4-3	Free standing instructions	10
5	Control Panel	11
5-1	Power switch	11
5-2	Display	11
5-3	Standby mode	12
5-4	Heating modes	12
5-5	Settings	15
5-6	Child lock	17
5-7	Reset to defaults	17
6	Connecting to WiFi	17
6-1	Downloading the app	17
6-2	Connecting to the app	18
7	Using the App	20
7-1	Home overview	20
7-2	Control interface	20
7-3	Choose mode	20
7-4	Device settings	22
7-5	Voice integration	22
8	Troubleshooting	24
9	Cleaning	24
10	Warranty	25
11	ERP Ecodesign Information	26
12	Disposal	27

1 | About the Manual

This manual describes the Ecostrad iQ Plus Panel Heater and details how to install and use the product. It is important to thoroughly review this manual before using the product.

For additional information regarding any aspect of the Ecostrad iQ Plus Panel Heater, contact:

Ecostrad Ltd.
Firecrest House
Lingerfield Business Park
Market Flat Lane
Knaresborough
North Yorkshire
HG5 9JA

Tel: 0330 880 7005
Email: customersupport@ecostrad.com
<https://ecostrad.com/>

2 | Warnings & Precautions

Read this manual carefully before using or installing the heater. Always store the manual in the immediate vicinity of the heater or its site of use.

Read all safety warnings and all instructions.

The heater should only be used according to the instructions in this manual. Failure to follow the warnings and instructions may result in electric shock, fire, serious injury, or all of the above. Save all warnings and instructions for future reference.



Warning

Children of less than 3 years should be kept away unless continuously supervised. Children aged from 3 years and less than 8 years shall only switch on/off the appliance provided that it has been placed or installed in its intended normal operating position and they have been given supervision or instruction concerning use of the appliance in a safe way and understand the hazards involved. Children aged from 3 years and less than 8 years shall not plug in, regulate, or clean the appliance, or perform maintenance.



Warning

This appliance can be used by children aged from 8 years and above and persons with reduced physical, sensory or mental capabilities or lack of experience and knowledge if they have been given supervision or instruction concerning the use of the appliance in a safe way and understand the hazards involved. Children shall not play with the appliance. Cleaning and user maintenance shall not be made by children without supervision.



Warning

Do not use the device in enclosed spaces if persons are present who cannot leave the room independently and are not under constant supervision.



Warning

To avoid overheating and risk of fire, do not cover the heater. Covering the heater for extended periods will activate the safety fuse, permanently disabling the heater.



Warning

In order to avoid a hazard due to inadvertent re-setting of the thermal cut-out, this appliance must not be supplied through an external switching device, such as a timer, or connected to a circuit that is regularly switched on and off by the utility.





Warning

Some parts of this product can become very hot and cause burns. Do not touch the surface when in operation. Do not install close to curtains or other combustible materials. Particular attention should be given where children and vulnerable adults are present.



- Keep the power cable away from all hot parts of the appliance.
- Do not use the heater with the power cable wound up. This can cause a dangerous build up of heat. Do not wind the cable around the appliance as this may cause weakening and splitting of the insulation. The power cable should be fully unwound and removed from any storage areas before use.
- Do not use the device if you detect damage to the mains plug or power cable. If the supply cord is damaged, it must be replaced by the manufacturer, its service agent or similarly qualified persons to avoid a hazard.
- All repairs and servicing must be carried out by a qualified person. To avoid danger any repairs must be completed by the manufacturer, a service agent of the manufacturer or a similarly qualified person.
- Make sure that the voltage indicated on the rating plate for this appliance corresponds to your power outlet.
- Check for transportation damage and make sure all parts are complete after the appliance is unpacked. Do not use if any parts are missing or damaged.
- Do not connect the product to the power supply until fully assembled and adjusted.
- It is recommended to plug the device directly into a wall socket. Use of extension leads is not recommended because many models do not support high-powered appliances. Make sure any extension lead used can safely support the power requirements of the product.
- The power cable should not be positioned under the carpet or items of furniture. Do not run the cable where it will be a trip hazard.

- Do not use this device in the immediate surroundings of a bath, shower, swimming pool or any other water container. Risk of electric shock. This product is not suitable for bathroom use. 
- The device must be placed where the switches and controllers cannot be touched by a person in a bathtub or shower.
- Do not use the device with wet or damp hands.
- No part of the appliance should be submerged in any type of liquid.
- Cleaning should be carried out using a damp cloth only. No abrasive chemicals or materials should be used.
- Never insert fingers or other objects or body parts into the device. Risk of electric shock or injury.
- The device must not be located immediately below an electrical socket outlet.
- Keep all objects at least 1m away from the front, side or back of the heater.
- When wall mounted, the following safety distances from surrounding surfaces must be observed: 20cm from the base of the heater to the ground; 80cm from the top of the heater to any ceiling or shelf; 15cm from the sides to non-flammable surfaces, e.g. brick walls; 30cm from the sides to flammable objects and surfaces, e.g. curtains or wooden walls. Keep the device at a minimum distance of one metre from curtains and other flammable materials.
- The device must only be installed in an upright and fixed position on a smooth, stable, heat-resistant surface.
- The device is for indoor use only.
- Make sure the minimum safety distances from walls and objects stated in the installation instructions are observed at all times. This is very important to prevent damage to walls, furniture and soft furnishings and to prevent the product overheating. 
- Do not use the device in rooms where contact with flammable or potentially explosive materials like dust, gas or vapour cannot be avoided.
- Do not use in rooms or environments that have a corrosive atmosphere.
- Do not use in places where food, artwork, or delicate scientific objects are stored.
- Do not put the appliance on a bed or long, thick carpet. This can cause the air inlet or outlet to become clogged and constitutes a fire risk.
- Do not operate the device when wet. If the device gets wet during cleaning, allow it to dry out before using.
- Do not expose the device to water jets.
- Do not transport the device during operation. 
- Do not sit on the device.
- Before carrying out maintenance, care or repair work on the device, ensure the device is unplugged. Do not use the cable to tug the plug from the socket. Hold the plug and pull.

- Switch the device off and disconnect the power cable from the mains socket when the device is not in use.
- Allow the device to cool down before touching or transporting the device, or attempting maintenance work.

3 | Technical Information

Table 1 | Specifications

Voltage	220-240V AC / 50Hz
Wattage	500W, 1000W, 1500W, 2000W, 2500W
Temperature setting Range Resolution	7-30 °C 1 °C
IP Rating	IP20
Appliance class	Class I
Power cable length	1.4m

4 | Installation

Read all safety instructions and warnings stated in the preceding section of this manual. Failing to follow these instructions can cause damage to life or property.



4-1 | Fixings

Before beginning installation, check that all fixings shown in **Table 2** are supplied. The heater should only be mounted with the manufacturer's fixings

Table 2 | Supplied fixings

Component	Image	Quantity
Bracket Screws (4*12mm)		6
Feet Screws (4*20mm)		4
Wall Screws (4*35mm)		2
Wall Plugs		2
Hanging Plates		2
Wall Brackets		2
Feet		2

4-2 | Wall mounting instructions

WARNING - Before switching on the appliance make sure that the heater is correctly fixed and is secure to the wall.



4-2-1 | Prepare the heater

Fix the hanging plates to the back of the heater using two 4*12mm screws for each plate as shown in **Figure 1**.

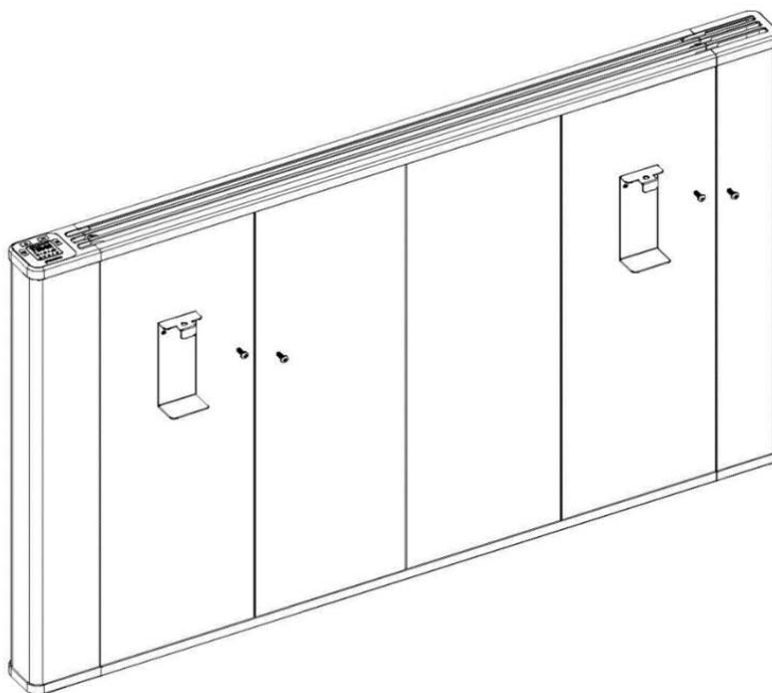

Figure 1 | Fixing the hanging plates

4-2-2 | Prepare the wall

Choose the mounting position, respecting the minimum distances from surrounding surfaces and objects shown in **Table 3** and **Figure 2**.

Table 3 | Minimum safety distances

From the top of the heater to shelves or ceiling	80cm
From base of heater to ground	20cm
From sides of heater to: Non-flammable surfaces (e.g brick walls) Flammable surfaces (e.g wooden walls)	15cm 30cm
From radiator to flammable materials and objects (e.g curtains)	1m

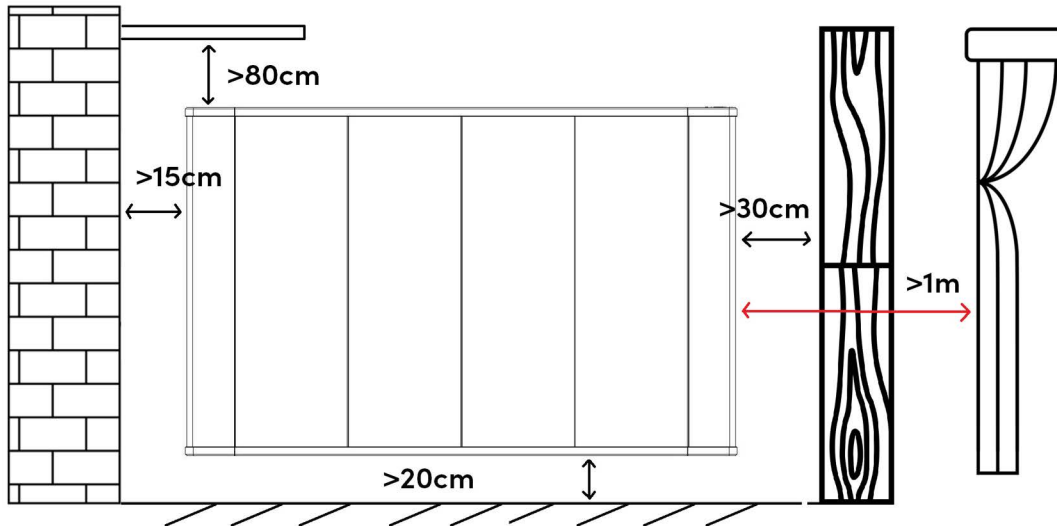

Figure 2 | Diagram of minimum safety distances

Fix the wall brackets:

- a. Use a tape measure and pencil to make two marks on the wall as per **Figure 3** and **Table 4**. The template provided will help you measure the width.

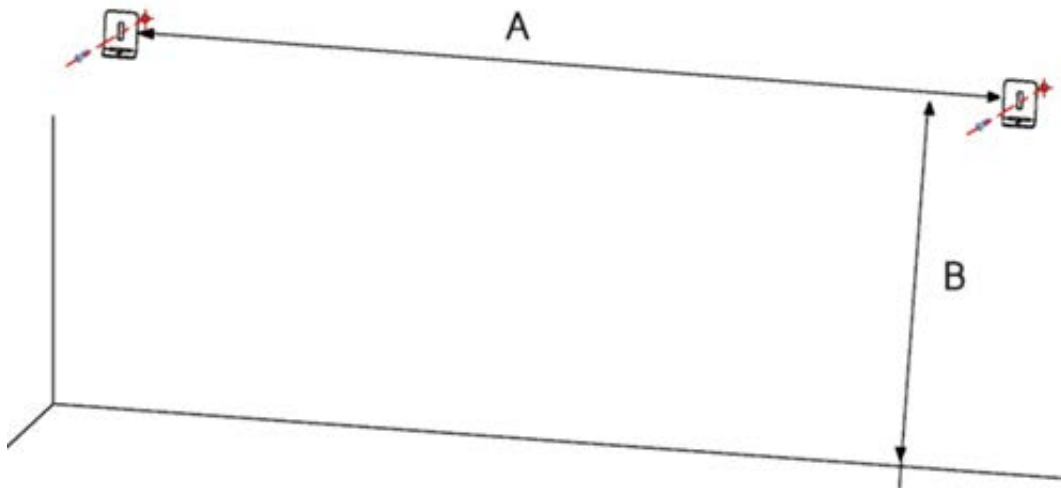

Figure 3 | Positions of drilling holes measurements

Table 4 | Mounting measurements

Heater width [mm]	A (Mounting Width) [mm]	B (Min. Mounting Height) [mm]
467	163	610
629	326	610
955	651	610
1118	814	610
1280	977	610

- b. Using a 6mm drill bit, drill two holes where you made your marks
- c. Knock a wall plug into each hole using a hammer.
- d. Position the wall hangers over the holes and use the 4*35mm screws to fix them in place.

4-2-3 | Hang the heater

Hang the heater on the wall brackets and fix in place with two 4*12mm screws, as in **Figure 4**.

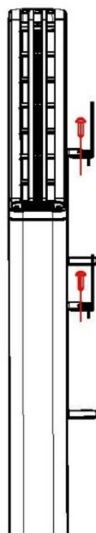

Figure 4 | Secure heater to wall brackets

4-3 | Free standing instructions

To use the heater free standing, you must first affix the feet:

1. Turn the heater upside down.
2. Align the holes on the feet with the holes on the base of the heater.
3. Use two 4*20mm screws to attach each foot (see **Figure 5**).

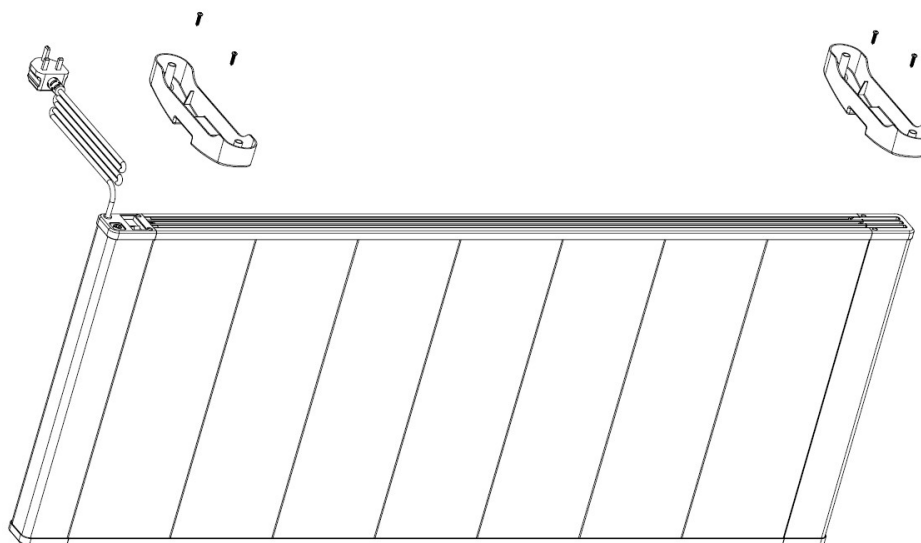

Figure 5 | Fixing the feet

5 | Control Panel

5-1 | Power switch

Before use the heater must be switched on at the mechanical switch at the base of the unit shown in Figure 6.

5-1-1 | Memory function

In the event of power failure or disconnection, program and temperature settings will be remembered and the heater will restart on the mode it was previously running. If the heater is connected to the WiFi, the time setting will synchronise with the app. If the heater is not connected to WiFi, the time will need to be re-set.



Figure 6 | Power rocker switch

5-2 | Display

The control panel, shown in Figure 7, includes a backlit LCD display. The backlight switches on when the panel is in use and times out after thirty seconds not in use.

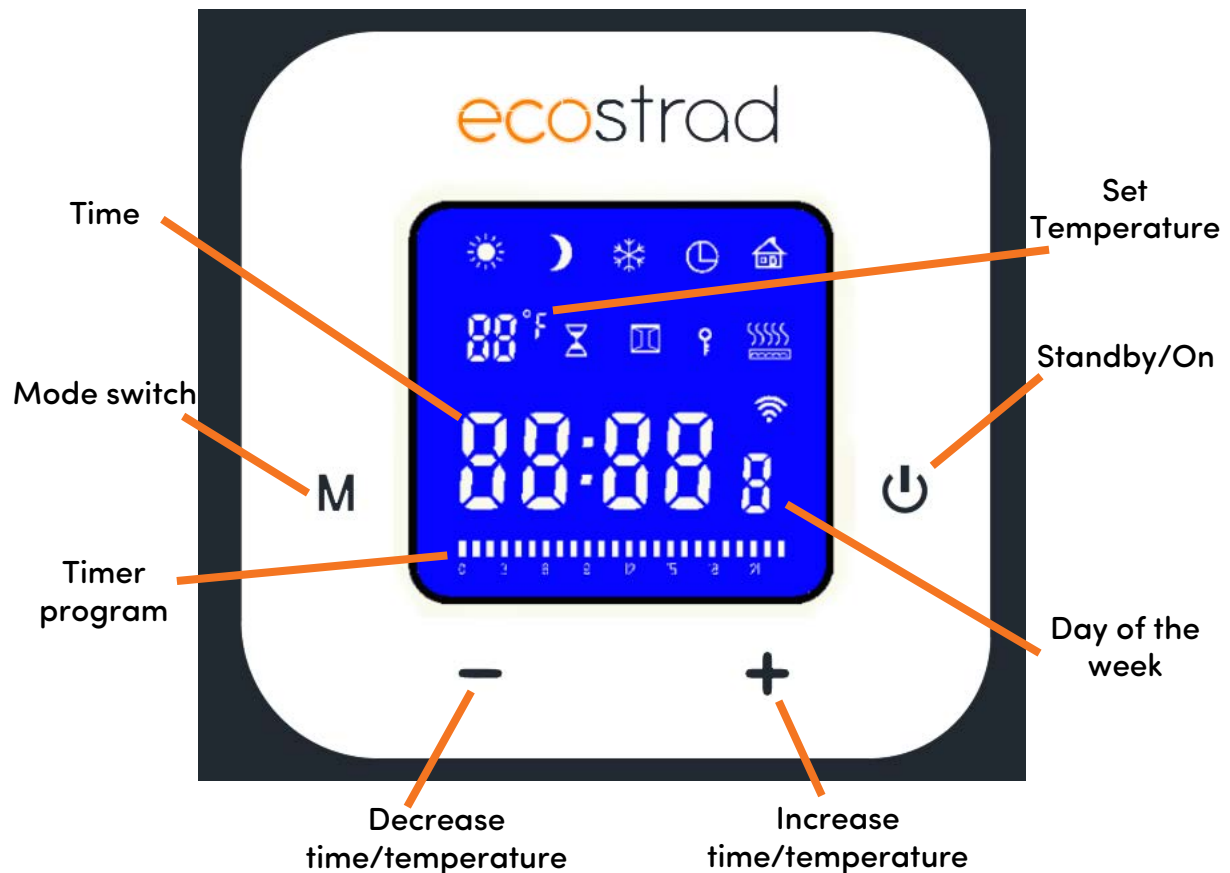













Figure 7 | Control screen

Icons used on the control panel can be found in **Table 5**.







Table 5 | Icons and their meanings

Symbol	Meaning	Symbol	Meaning
	Comfort		Keypad locked
	Eco		Connected to WiFi
	Anti-freeze		Device is heating
	Timer		Open window detected
	Boost mode		LST mode

5-3 | Standby mode

When the heater first switches on it appears in standby mode, where the time is displayed and the heater will not heat. You can use the  button to switch between standby and heating modes. When the heater first turns on, the time will appear as 00:00. You can set the correct time in timer mode, see section **5-4-4**.



5-4 | Heating modes

Tap the  button to switch the heater on. Tap **M** to switch between modes. The icon on the display will change accordingly, browsing through: Comfort , Eco , Anti-Freeze , Timer  and Boost mode .



You can also scan this QR code to watch a instructional video on using the following heating modes.



5-4-1 | Comfort mode

When the  icon (and only the  icon) displays on the screen, you are in comfort mode. In this mode, the heater heats to a constant set temperature. The thermostat measures the room temperature and switches the heating on and off accordingly. The  icon displays when the heater is heating.



The default set temperature is 19 °C. Set temperature can be adjusted using the  and  buttons. Set temperature range is 7-30 °C.

The temperature set in comfort mode also applies to comfort intervals when they occur in timer mode.

5-4-2 | Eco mode 🌙

When the 🌙 icon (and only the 🌙 icon) displays on the screen, you are in eco mode. Just like comfort, in this mode the heater heats to a constant set room temperature. However, eco mode is designed to be set to a lower temperature, providing a low-heat, energy-saving alternative for when you are sleeping or out.



Set temperature range is 7-30 °C and can be adjusted using the **-** and **+** buttons.

The temperature set in eco mode also applies to eco intervals when they occur in program mode.

5-4-3 | Anti-freeze mode ❄️

When the ❄️ icon displays on the screen, you are in anti-freeze mode. This is the mode to use when rooms are empty for long periods – for instance, when you go on holiday. Anti-freeze sets the heater to come on only when temperatures drop low, keeping the room warm enough to prevent pipes from freezing.



Anti-freeze mode is set to 7 °C. This is not adjustable.

5-4-4 | Timer 🕒

When the 🕒 icon displays on the screen, you are in timer mode. On this mode the heater will heat as per your set program. You can adjust set time and program from this screen by holding down the **M** button. **NOTE** - this menu times out after 30 seconds.



Setting the time

- Hold down the **M** key until the hours appear.
- Use the **-** and **+** keys to set the hour.
- Press **M** to confirm. The minutes will appear.
- Use the **-** and **+** keys to set the minutes. Press **M** to confirm. The day of the week will appear.
- Use the **-** and **+** keys to set the day of the week, where 1 = Monday, 2 = Tuesday and so on.
- Press **M** to confirm. The display will move to the program setting stage.

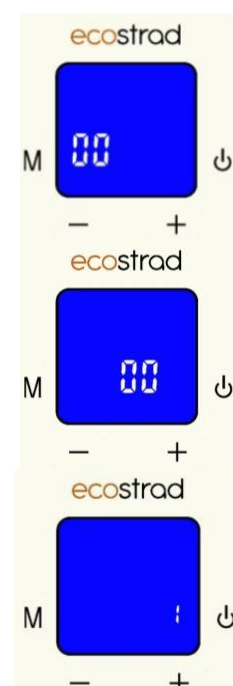

Setting the program

The timer allows you to set a different program for every day of the week. P1 is the schedule for Monday, P2 is the schedule for Tuesday, and so on. Each program consists of 24 hourly slots where you can set either comfort ☀ or eco 🌙 mode. The heater will heat at the temperatures you set on comfort and eco mode.

Follow the instructions above for setting the time. When P1 appears on the screen, you are ready to start setting your program:

- P1 and 00 will be on the screen. This means you are choosing a mode for midnight on Monday morning.
- Press the **+** key to set comfort mode and the **-** key to set economy mode.
- The bars at the bottom of the screen will change to reflect your choice – top bar for comfort, no bar for eco, and the display will advance to P1 01 – 1am on Monday.
- Continue pressing **+** and **-** to set comfort ☀ and eco 🌙 modes for the rest of the day. When you get to the end of the day, the time will begin again at 00, midnight. You can go through the program as many times as you need to get it right.
- When you are happy with the program for Monday, press **M** to move on to Tuesday.
- P2 and 00 will appear on the screen. This means you are choosing a mode for midnight on Tuesday morning. Repeat the steps above to choose mode for each hour.
- Press **M** to confirm and move on to Wednesday.
- Continue this process until each day of the week is set. Press **M** to confirm and return to timer mode. The heater will heat as per your new program.

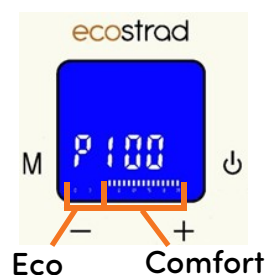

If you are struggling with the process of setting the program, scan this QR code to watch an easy-to-follow programming video.



5-4-5 | Boost mode ⌚



When the ⌚ icon displays on the screen, the heater is in boost mode. When this mode is selected, the heater will work to a 30 °C set temperature for the length of time shown on the display. The default time is 2 hours. You can adjust this time using the **+** and **-** keys, from 30 minutes to 8 hours, in intervals of half an hour.



Whilst boost is running the time on the display counts down in steps of 30 minutes. When this time elapses, the heater switches to standby mode.

5-5 | Settings

The settings menu allows you to enable, disable and configure all the heater's supplementary functions: temperature compensation (F0), open window detection (F2), low surface temperature setting (F3), WiFi function (F4) and time synchronisation (F5).

Press  to put the heater into standby mode and hold down  for 5 seconds to enter the settings menu. **NOTE** - this menu times out after 15 seconds.

You can also scan this QR to watch an instructional video on using the advanced settings.







5-5-1 | Temperature compensation (F0)



The temperature compensation setting allows users to adjust for any discrepancy between the average room temperature and the temperature sensed by the thermostat. For instance, if the temperature in the room is 18 °C, but the heater is sensing 16 °C, a compensation factor of +2 °C will offset the difference.





The accuracy of the heater's temperature reading can be compromised if the unit is mounted such that the sensor is positioned in a hot or cold spot – such as hot water pipes or a draughty doorway. The sensor is at the bottom right of the unit.

- Press  to put the heater into standby mode and hold down  for 5 seconds to enter the settings menu.
- F0 will appear on the screen, followed by the current set temperature compensation. Default is 0 °C.
- Use the  and  keys to adjust. Temperature compensation can be adjusted from -5 to 5 °C in steps of 1 °C.
- Press  to confirm and move onto the next setting.

5-5-2 | Open window detection (F2)

Open window detection is an energy-saving feature designed to cut power to the unit if a window is opened. If the heater detects a sudden drop in temperature (2 °C or more within 5 minutes, the  icon will appear and the heater will switch to anti-freeze mode  to prevent energy wastage as heat escapes through the window. The F2 setting controls how long the heater waits before switching back to the original heating mode. Open window detection is disabled by default.

- Press  to put the heater into standby mode and hold down  for 5 seconds to enter the settings menu.
- Press  to skip through the settings until F2 appears on the screen, followed by the current setting. Default is "oF" - disabled.

- Use the **+** and **-** keys to adjust. Choose 60 or 90 to enable the feature and set the number of minutes, or choose “oF” to disable detection.
- Press **M** to confirm and move onto the next setting.

5-5-3 | Low surface temperature setting (F3)

The LST setting allows you to lower the heater’s temperature limit, providing peace of mind if you’re using the heater in a room where children or vulnerable adults are present. When this setting is disabled, the heater runs at its default safety limit: if the internal thermostat detects a temperature over approx. 70 °C, the heater will stop heating until it drops back below the limit. Enabling the LST setting gives you a choice of five lower limits: approx. 40 °C, 45 °C, 50 °C, 55 °C and 60 °C. While some parts of the device may get hotter than this limit, depending on environmental factors, the overall maximum temperature of the heater will be significantly reduced.

When the LST setting is enabled, the  symbol shows on the display.

Please be aware that lowering the temperature limit will reduce the heater’s maximum heat output, which may impact its effectiveness in your space. If you plan to use the temperature limit permanently, you may need to install additional heaters in your room to compensate. The LST setting is disabled by default.

- Press  to put the heater into standby mode and hold down **+** for 5 seconds to enter the settings menu.
- Press **M** to skip through the settings until F3 appears on the screen, followed by the current setting. Default is “oF” - disabled.
- Use the **+** and **-** keys to adjust. Low surface temperature can be set to 40, 45, 50, 55, 60, or “oF” to disable.
- Press **M** to confirm and move onto the next setting.

5-5-4 | WiFi function (F4)

This setting allows you to enable or disable the heater’s connection to WiFi. Disabling the connection is temporary: if you have already added the heater to your app account, disabling the connection will not remove it. You will be able to control via the app as soon as you re-enable the connection. The  icon appears on the screen when the WiFi function is enabled: when it is flashing, the connection has been lost or not yet made; when it is steady, a connection is active.

- Press  to put the heater into standby mode and hold down **+** for 5 seconds to enter the settings menu.
- Press **M** to skip through the settings until F4 appears on the screen, followed by the current setting. Default is “oN” - enabled.
- Use the **+** and **-** keys to adjust. Select “oN” to enable and “oF” to disable.

- Press **M** to confirm and move onto the next setting.

5-5-5 | Time synchronisation (F5)

This setting controls whether the time set on the heater automatically synchronises with the time on the app when the unit is controlled via WiFi.

- Press **⏻** to put the heater into standby mode and hold down **+** for 5 seconds to enter the settings menu.
- Press **M** to skip through the settings until F5 appears on the screen, followed by the current setting. Default is “oN” - enabled.
- Use the **+** and **-** keys to adjust. Select “oN” to enable and “oF” to disable.

Press **M** to confirm and move onto the next setting.

5-6 | Child lock ?

Press and hold the **M** and **⏻** keys for 5 seconds to lock the display. The **?** icon will appear and all keys will be locked, except for standby button. To unlock, repeat this process, and the **?** icon will disappear.

5-7 | Reset to defaults

Press **⏻** to put the heater in standby mode. Press and hold the **⏻** key for 10 seconds to restore the device to default settings: Comfort: 19 °C, Eco: 19 °C, Time: 00:00, Day: 1 (Monday), Program: 24/7 Eco Intervals, Temperature Compensation: 0 °C, Open Window Detection: Disabled, LST Setting: Disabled, WiFi Function: Enabled, Time Synchronisation: Enabled.

6 | Connecting to WiFi

6-1 | Downloading the app



The Ecostrad iQ Plus Panel Heater is designed to work with the Smart Life app.

Scan the code below to go to the app. Press install and follow the app's instructions to create an account.



NOTE – The Smart Life app is a constantly evolving third party system. This guide was correct at time of printing but may differ slightly from future versions. The app is designed to work on Android or iOS but older software versions may affect app presentation and performance.

6-2 | Connecting to the app

1. Ensure WiFi control is enabled in the heater settings. If the  icon is flashing, the WiFi connection is enabled and you can move to step 2. If the icon is not flashing, go to section 5-5-4 and follow the instructions to enable.
2. To put the heater in pairing mode, press  to enter standby mode and hold down **M** until the screen switches to the connection screen. This begins a 99 second count down, giving you 3 minutes to make the connection on the app.
3. On the home page of the app, press + or "Add Device".
4. The app should start scanning, as shown by the icon at the top of the screen (see **Figure 8**). If this icon and text does not show, press  in the top right-hand corner.

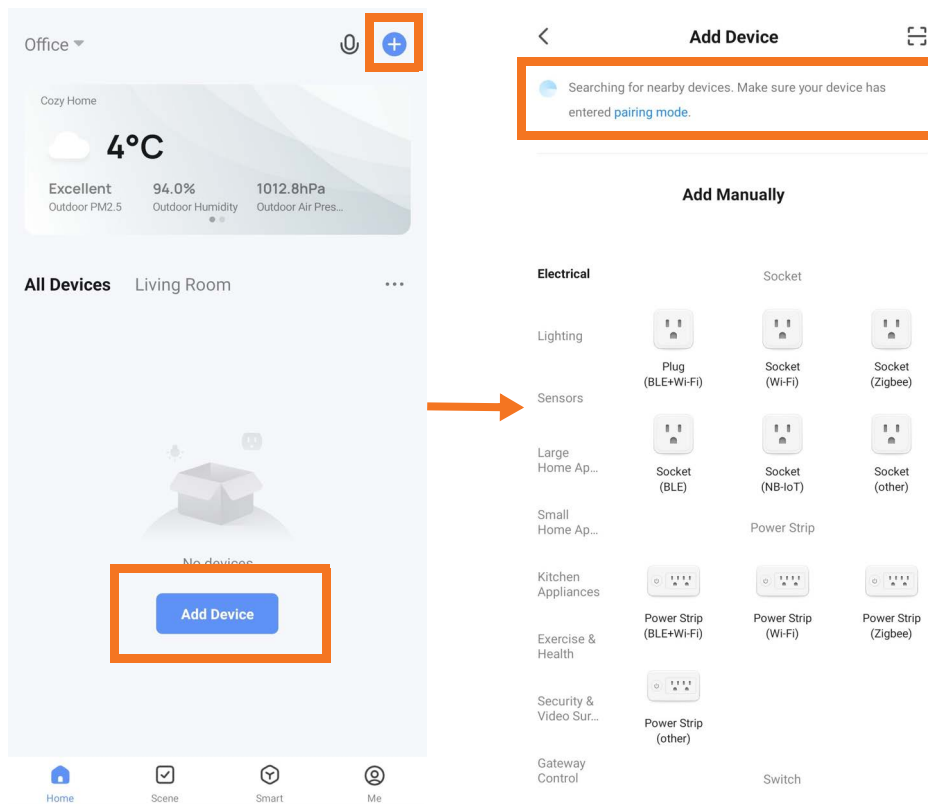

Figure 8 | Adding device on Smart Life app

5. The app will demonstrate that it has found the heater (**Figure 9**). Press "Add".
6. The app may ask you to choose your WiFi network and enter the password. Press "Next".
7. The heater will begin connecting. When it is successfully added, the word "PASS" will show on the display screen and a tick mark will appear beside the heater on the app. Press "NEXT", as shown in **Figure 9**.



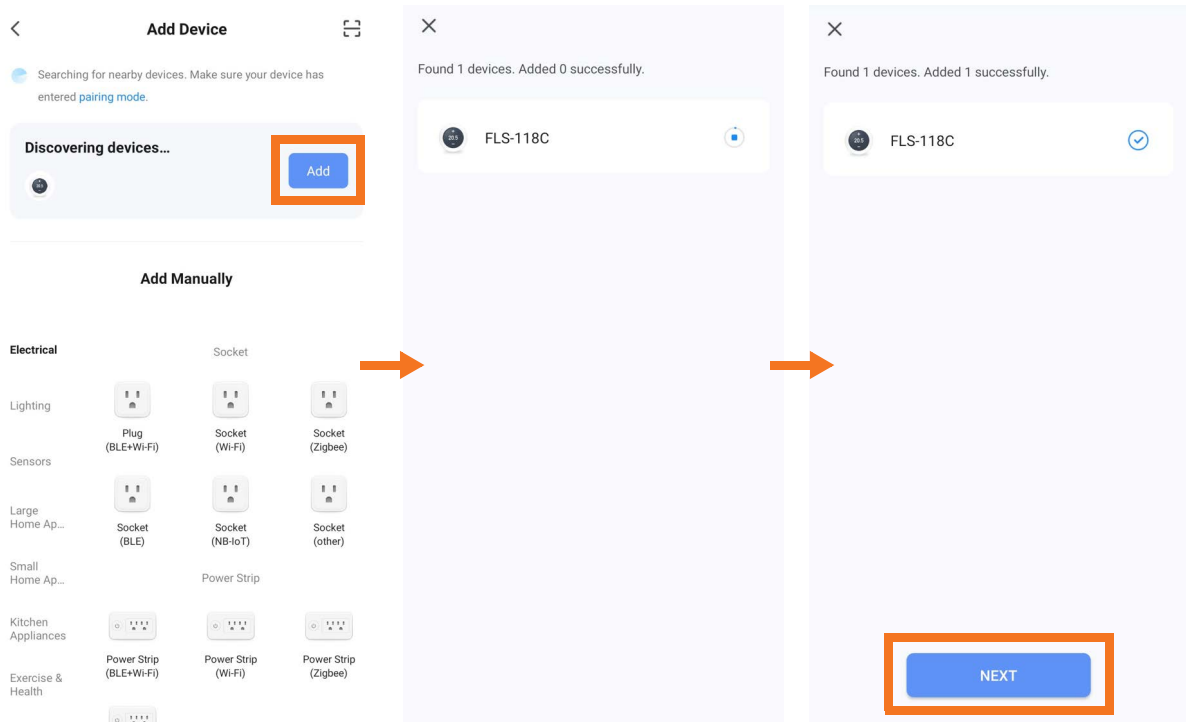

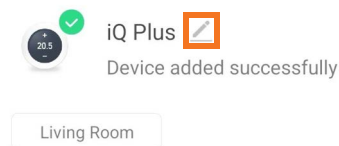

Figure 9 | Finding device on Smart Life app

8. When successfully connected, the heater will appear as below on the app. Press  to change its name or "Done" to return to the home screen.

Done

Added successfully



WiFi Connection – Troubleshooting

If your heater does not connect on the first attempt:

- Make sure both the heater and your smart device are in range of your router.
- Make sure you complete the connection process in 99 seconds. If the display reaches the end of the countdown, it will show "FAIL" on the display, and you must begin the process again.
- Ensure your router has a strong internet connection.
- Ensure WiFi and Bluetooth are enabled on your smart device.



- Depending on your device type and settings, location services may need to be enabled to achieve connection.
- Make sure the app has registered successfully.
- Make sure your smart device is connected to the same WiFi network as that to which you are attempting to connect the heater.
- Ensure you are connected to a 2.4G WiFi band. See instructions within the app if you are currently connected to a 5G band.
- Check any local restrictions on your WiFi. WiFi networks in public places such as hotels and airports may require extra identification steps.

7 | Using the App

NOTE – The Smart Life app is a constantly evolving third party system. The guide below was correct at time of printing but may differ slightly from future versions.

7-1 | Home overview

You can use the Smart Life app to control multiple devices. All devices are displayed on the home screen with their status.

Possible statuses:

- Online – Heater will respond to app commands.
- Offline – Device is turned off at wall or power switch. It cannot be controlled by the app.

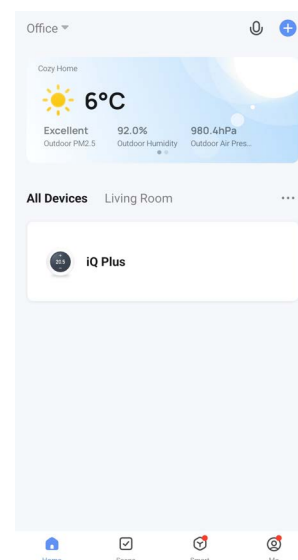

7-2 | Control interface

Tap the heater listing to go to the control interface, as demonstrated in **Figure 10** below.

Here you can turn the heater off and on, adjust set temperatures, choose mode and access weekly programmer and device settings.

7-3 | Choose mode

Tap the mode icon  on the control interface to choose mode. The four options correspond to the five modes on the control panel.

7-3-1 | Comfort, eco & anti-freeze mode

In comfort and eco mode, simply use the sliding dial or the – and + keys to adjust the set temperature. The anti-freeze set temperature cannot be adjusted.

Mode	
Comfort Mode	✓
Eco Mode	
Anti-Freeze Mode	
Program Mode	
Boost Mode	
Cancel	

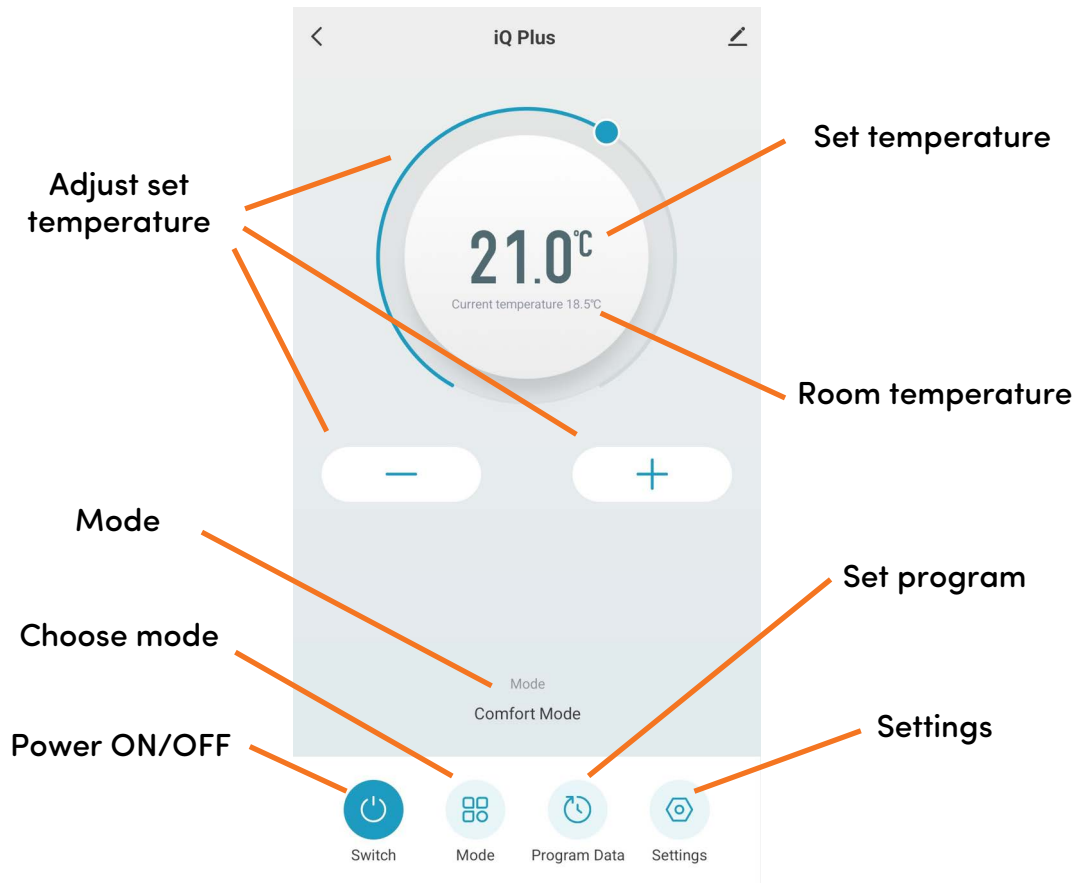

Figure 10 | Control interface on Smart Life app

7-3-2 | Program mode

Tap the program data  icon on the control interface to configure a program.

The program consists of 24 hourly intervals for each day, which you can set to comfort or eco temperature.

Tap the interval to choose comfort (yellow bar) or eco (green bar). You can drag the start and end times of each mode block to make setting your program quick and easy.

NOTE – your set program will only run in program mode.

7-3-3 | Boost mode

In boost mode the heater works to its maximum set temperature of 30 °C. You can adjust how long the heater works in boost mode using the timer slider, as shown in **Figure 11**.

NOTE – the slider does not "count down" to show you how much time remains on boost mode. However, once the time elapses, the app will show the heater switching to standby mode. You can check how much time remains – rounded to the nearest half hour – on the heater display.



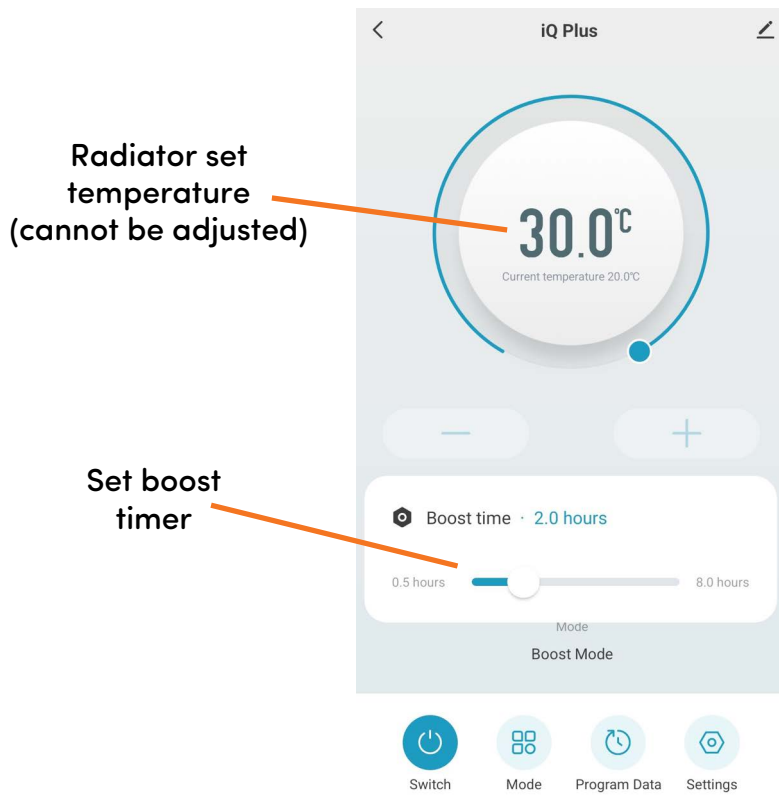



Figure 11 | Boost mode on the iQ Plus

7-4 | Device settings

Tap the  icon to view and adjust the heater’s settings. These correspond to the settings available in the advanced settings of the control panel.

Tap the  icon for settings that relate to the heater’s listing on the app, including its name, any automations it is included in, and the quality of its network connection.

7-5 | Voice integration

The Smart Life app is compatible with both Amazon Alexa and Google Home.



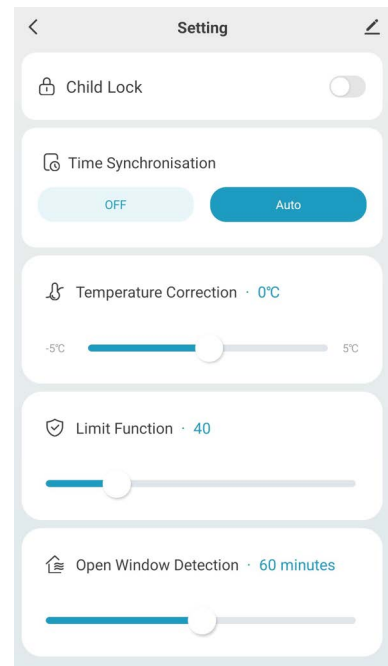





To connect Alexa with Smart Life, download the Smart Life skill onto your Alexa app. To connect Google Home with Smart Life, go to “Set up a device” in the Google Home app. Tap “Works with Google” and select Smart Life from the list.



Depending on your device, your voice control app may discover your heaters automatically, or you may need to prompt it to do so. You can find quick guides for both Google Home and Alexa in the Smart Life app's FAQ section.

Make sure you give the heater a name that's easy for you to say and for your voice interface to understand. You can change the heater's name in the Smart Life app.

Table 6 | Voice control commands

	Command	Action
	<ul style="list-style-type: none"> • Turn on <device name>. • Switch on <device name>. 	Switches heater on.
	<ul style="list-style-type: none"> • Turn off <device name>. • Switch off <device name>. 	Switches the heater off.
°C	<ul style="list-style-type: none"> • Set <device name> to <temperature> degrees. 	Choose value from 7 to 30. This command only has an effect in comfort, eco, and Timer mode.
	Alexa <ul style="list-style-type: none"> • Set <device name> to heat. Google Home <ul style="list-style-type: none"> • Set <device name> hot. 	Switches to comfort mode.
	<ul style="list-style-type: none"> • Set <device name> to eco. 	Switches to eco mode
	Alexa <ul style="list-style-type: none"> • Set <device name> to cool. Google Home <ul style="list-style-type: none"> • Set <device name> cold. 	Switches to anti-freeze mode.
	<ul style="list-style-type: none"> • Set <device name> to auto. 	Switches to Timer mode.
 	<ul style="list-style-type: none"> • Increase <device name> temperature. • Decrease <device name> temperature. • Make <device name> warmer. • Make <device name> cooler. • Raise <device name> temperature. • Lower <device name> temperature 	Increases or decreases the set temperature by 1 °C, as above.
<x> °C	<ul style="list-style-type: none"> • Increase <device name> <x> degrees. • Decrease <device name> <x> degrees. • Raise <device name> <x> degrees. • Lower <device name> <x> degrees. 	Increases or decreases the set temperature by a number of degrees.
?	What temperature is the <device name> set to?	Reports the set temperature of the heater.

8 | Troubleshooting

Issue	Explanation	Solution
Heater is not heating. Er code displaying.	Temperature sensor has become disconnected, or heater has short circuited.	The heater will not heat while either sensor is disconnected. Contact the seller (section 1) to arrange repair or replacement.

9 | Cleaning

The heater should be cleaned regularly to ensure fault-free operation. The most common cause of overheating is the build-up of dust or fluff within the heater. Prevent this from happening by regularly unplugging the heater and dusting the vents and grille.

1. First unplug the heater and ensure it has cooled down before cleaning.
2. Wipe the surface gently with a soft cloth dipped in water or kitchen surface cleaner.
3. Protect the inside of the product and control panel from water ingress.
4. Let the product dry naturally before using again.
5. If you need to store the product, house it in its original packaging and store it in a dry and ventilated place.

NOTE - Do not use solvents such as alcohol, gasoline, lacquer thinner or toluene to wash the product. This can cause the body to yellow and corrode.

10 | Warranty

The Ecostrad iQ Plus Panel Heater carries a 10-year guarantee on the body, a 3-year guarantee on paintwork and a 2-year guarantee on electrical components. Within the stated period, starting from the date the customer receives their unit, Ecostrad guarantee to repair or replace the unit where a fault is due to defects in materials or manufacturing.

The warranty does not cover any defect arising from damage, negligence, usage outside the product's intended purpose or fair wear and tear. The warranty is only valid when the unit has been used at the specified supply voltage, and in accordance with all conditions specified in this manual. The warranty will be void if the heater has been covered, tampered with or opened in any way, or if the ratings label has been removed.

The warranty does not cover failures and faults due to force majeure, accidental damage, mishandling, external impact, chemical agents or atmospheric phenomena, incorrect use of the device, the purchaser's faulty electrical installations, transporting the device or problems caused by the device being handled by persons not authorised by Ecostrad. If the unit has been hardwired, an invoice may be required to confirm the work was carried out by a qualified professional. Ecostrad cannot accept responsibility for damage, loss or injury caused by incorrect installation, maintenance, cleaning or covering the device.

The warranty is a contract with the original purchaser and does not transfer if the unit is re-sold, gifted or inherited. Proof of purchase, including order number and order confirmation or invoice, will be required if a claim is made. The warranty covers only the model of heater shown on the purchase invoice. The warranty covers the repair or replacement of the defective product only and Ecostrad shall have no liability for installation costs or consequential losses however incurred. The unit is sold as a DIY product; whilst hardwiring is permitted within the terms of the warranty – provided evidence can be produced that the work was performed by a qualified installer – no compensations will be offered for the installer's costs in the event of a claim. Claims must be made with the establishment where the device was purchased. This warranty does not affect the customer's consumer rights.

11 | ERP Ecodesign Information

Table 7 | Output guidelines

Model	500W	1000W	1500W	2000W	2500W
Heat output					
Nominal heat output (P_{nom} /kW)	0.47	0.98	1.48	1.97	2.48
Minimum heat output (indicative) (P_{min} /kW)	0	N/A	N/A	N/A	N/A
Maximum continuous heat output ($P_{max.c}$ /kW)	0.47	0.98	1.48	1.97	2.48
Auxiliary electricity consumption					
At nominal heat output (el_{max} /kW)	0	0	0	0	0
At minimal heat output (el_{min} /kW)	0	0	0	0	0
In standby mode (el_{sb} /kW)	0.46	0.45	0.46	0.47	0.47

Table 8 | Information requirements for electrical space heaters

Item	Unit
Type of heat input, for electric storage local space heaters only (select one)	
manual heat charge control, with integrated thermostat	N/A
manual heat charge control with room and/or outdoor temperature feedback	N/A
electronic heat charge control with room and/or outdoor temperature feedback	N/A
fan assisted heat output	N/A
Type of heat output/room temperature control (select one)	
single stage heat output and no room temperature control	[no]
Two or more manual stages, no room temperature control	[no]
with mechanic thermostat room temperature control	[no]
with electronic room temperature control	[no]

Table 8 | Information requirements for electrical space heaters

Item	Unit
electronic room temperature control plus day timer	[no]
electronic room temperature control plus week timer	[yes]
Other control options (multiple selections possible)	
room temperature control, with presence detection	[no]
room temperature control, with open window detection	[yes]
with distance control option	[yes]
with adaptive start control	[no]
with working time limitation	[no]
with black bulb sensor	[no]

12 | Disposal



In accordance with WEEE Directive 2012/19/EU, the icon with the crossed-out waste bin on electrical or electronic equipment stipulates that this equipment must not be disposed of with household waste at the end of its life. You will find collection points for free return of waste electrical and electronic equipment in your vicinity. The addresses can be obtained from your local authority.

The separate collection of waste electrical and electronic equipment enables the re-use, recycling and other forms of recovery of waste equipment, and prevents any negative effects for the environment or human health caused by the disposal of hazardous substances potentially contained in the equipment.